

# MODEL: CN-90LH

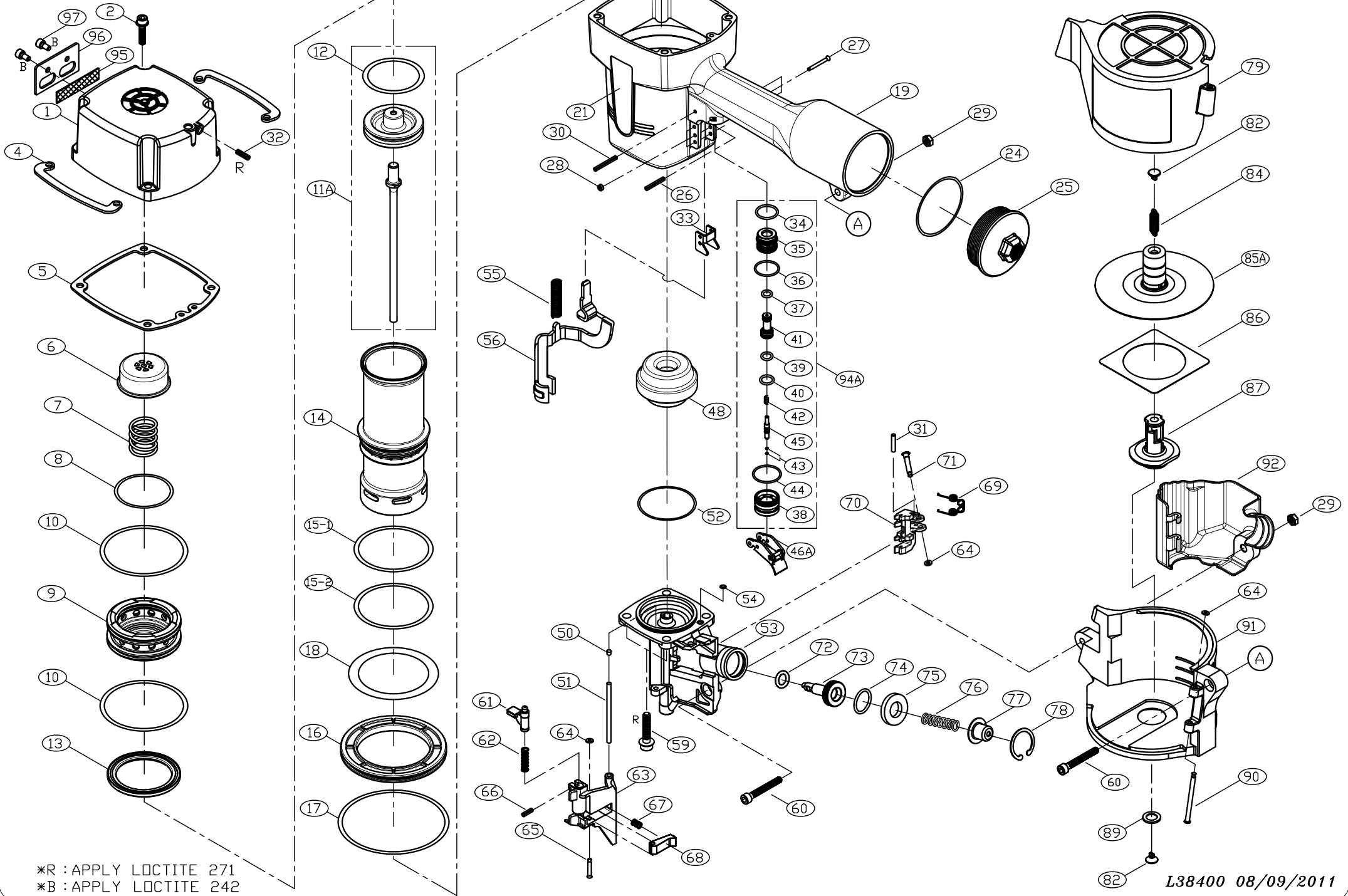

\*R: APPLY LOCTITE 271  
 \*B: APPLY LOCTITE 242

## PARTS LIST (CN-90LH)

\*WHEN ORDERING SPARE PARTS, PLEASE STATE ITEM No, PART NO. AND DESCRIPTION.

ITEM	PART NO	DESCRIPTION	QTY	ITEM	PART NO	DESCRIPTION	QTY	ITEM	PART NO	DESCRIPTION	QTY
001	36100101	CAP	1	038	23303801	TRIGGER VALVE CAP	1	076	23307601	COMPRESSION SPRING	1
002	HS06100LW-30	HEX. SOC. HD. BOLT+SW	4	039	OR06819M	O RING**	1	077	23307701	SPRING COLLAR	1
004	36101201	PROTECTOR	2	040	OR08819N	O RING**	1	078	CR2600R	C RING**	1
005	36101002A	CYLINDER CAP SEAL	1	041	23304103	VALVE PLUNGER	1	079	25407901	MAGAZINE COVER	1
006	36100201	PISTON STOPPER	1	042	15108301	SPRING	1	082	23308201	SPRING RECEIVER^	2
007	28000801	COMPRESSION SPRING	1	043	OR02514M	O RING**	2	084	23308401	TENSION SPRING	1
008	OR52030N	O RING**	1	044	OR21015N	O RING**	1	085A	25408501A	NAIL SUPPORT UNIT	1
009	28001101	PISTON HEAD VALVE	1	045	23304501	PLUNGER	1	086	23308601	RUBBER PLATE	1
010	OR68030N	O RING**	2	046A	23304301A	TRIGGER ASSEMBLY^	1	087	25408701	MAGAZINE POST	1
011A	38400501A	DRIVER ASSEMBLY	1	048	36100701	BUMPER	1	089	25408901	POST RETAINER	1
012	OR50253N	O RING**	1	050	23305001	PIN CAP	1	090	23309001	STEP PIN	1
013	28001201	SEAL	1	051	23305101	STRAIGHT PIN	1	091	25409101	MAGAZINE	1
014	38400301	CYLINDER	1	052	OR53718N	O RING**	1	092	35009201	CONTACT ARM COVER	1
015-1	OR64431N	O RING**	1	053	36100902	NOSE	1	094A	23303804A	TRIGGER VALVE ASSEMBLY^	1
015-2	OR65040N	O RING**	1	054	OR04515N	O RING**	1	095	38400801	MUFFLER	1
016	38400601	CYLINDER RING	1	055	23305501	COMPRESSION SPRING	1	096	38400701	EXHAUST FILTER	1
017	OR94431N	O RING**	1	056	36101101	CONTACT ARM UNIT	1	097	HS05080B-12	HEX. SOC. HD. BOLT	2
018	OR62953N	O RING**	1	059	HS08125B-30	HEX. SOC. HD. BOLT	4				
019	36100801	BODY	1	060	HS06100B-35	HEX. SOC. HD. BOLT	2				
021	23302101	PLASTIC LABEL	2	061	23306101	DOOR LATCH	1				
024	OR54431N	O RING**	1	062	23306201	COMPRESSION SPRING	1				
025	23302501	END CAP	1	063	25406301	DOOR	1				
026	RP3020S	ROLLED PIN	1	064	23306401	RUBBER WASHER**	3				
027	23302701	STEPPED PIN	3	065	23306501	STEP PIN	1				
028	OR01919N	O RING**	3	066	RP3012S	ROLLED PIN	1				
029	LN0600NB	LOCK NUT	2	067	23306701	COMPRESSION SPRING	1				
030	RP3030S	ROLLED PIN	1	068	23306801	CHECK PAWL	1				
031	RP3016S	ROLLED PIN	1	069	23306902	TORSION SPRING	1				
032	SS06100B-06	SET SCREW	1	070	23307002	FEED PAWL	1				
033	23303301	CONTACT ARM GUIDE	1	071	23307101	STEP PIN	1				
034	OR15618N	O RING**	1	072	OR09819N	O RING	1				
035	23303501	TRIGGER VALVE	1	073	25407301	FEED PISTON	1				
036	OR17515N	O RING**	1	074	OR20724N	FEED PISTON O RING**	1				
037	OR05819N	O RING**	1	075	23307501	FEED PISTON STOP	1				