

KP-P50-779 Pneumatic Plier Stapler (KP-779 staple)

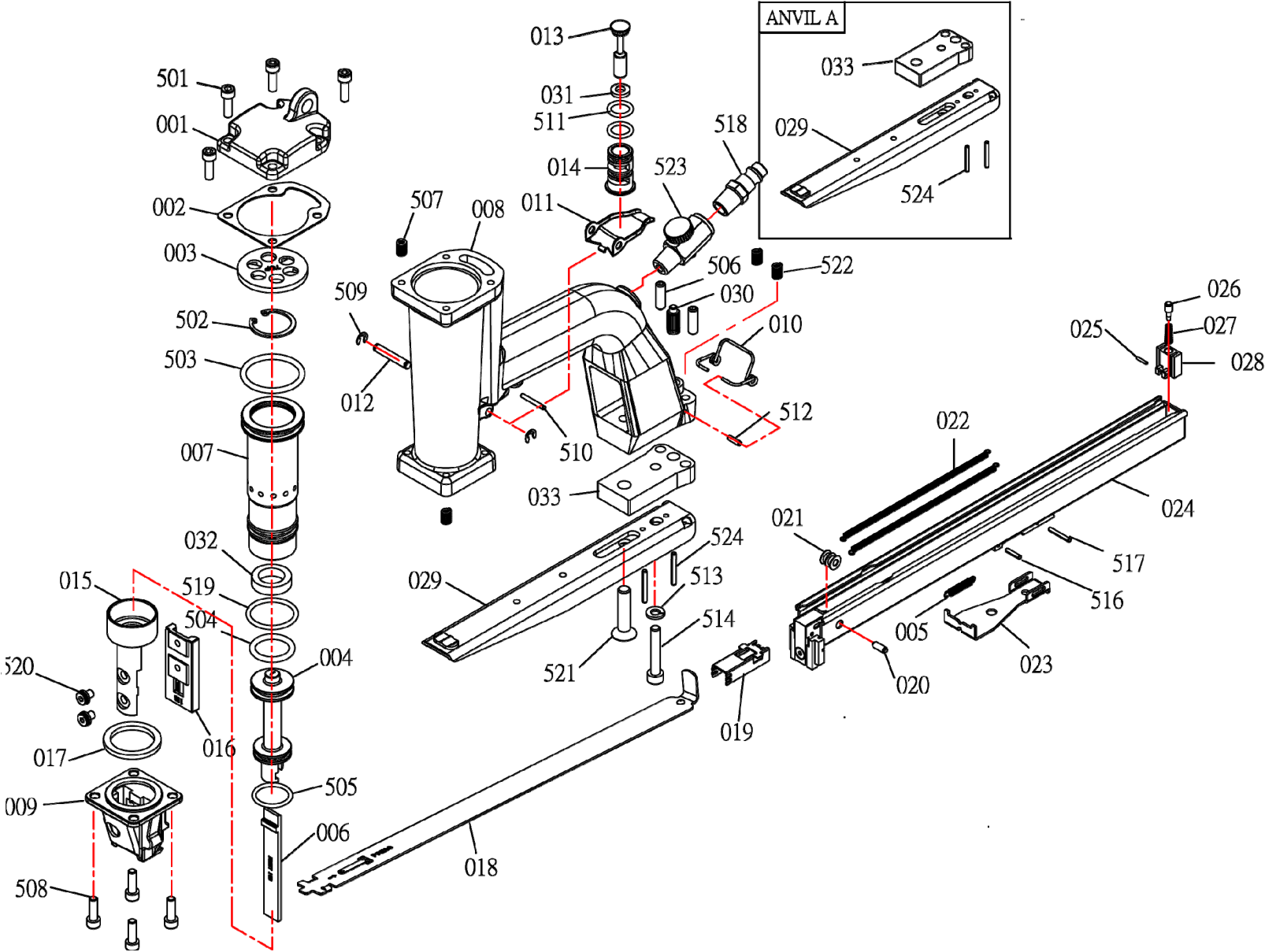

KP-P50-779 Plier Stapler

ITEM	PARTS NO.	DESCRIPTION	Q'TY	SPEC.
001	A05500101	CAP	1	
002	A05500201	PACKING	1	
003	A05500301	BUMPER	1	
004	A05500401	DRIVER PISTON	1	
005	A05500501	SPRING	1	
006	A05500601	DRIVER	1	10B series
006	A07500201	DRIVER	1	5B series
006	A10300301	DRIVER	1	5A series
006	A12400101	DRIVER	1	777 series
006	A12500101	DRIVER	1	779 series
007	A05500701	CYLINDER	1	
008	A05500801	BODY	1	
009	A05500902	GUIDE	1	
010	A05501001	SPRING	1	
011	A05501101	TRIGGER	1	
012	A05501201	ROD	1	
013	A05501301	VALVE	1	
014	A05501401	TUBE	1	
015	A05501501	SLEEVE	1	
016	A05501601	DRIVER GUIDE	1	10B series
016	A07500101	DRIVER GUIDE	1	5B series
016	A10300101	DRIVER GUIDE	1	5A series
016	A05501602	DRIVER GUIDE	1	10B-10 series
016	A07500102	DRIVER GUIDE	1	5B-10 series
016	A10300102	DRIVER GUIDE	1	5A-10 series
016	A12400201	DRIVER GUIDE	1	777 series
016	A12500201	DRIVER GUIDE	1	779 series
017	A05501701	BUMPER	1	
018	A05501902A	COVER UNIT	1	
019	A05502401	PUSHER	1	
019	A12400401	PUSHER	1	777&779 series
020	A05502601	ROD	1	
020	A12400601	ROD	1	777&779 series
021	A05502501	ROLLER	1	
021	A12400501	ROLLER	1	777&779 series
022	A05502301	SPRING	2	
023	A05502701	MAGAZINE CLAMP	1	
024	A05503401A	MAGAZINE SET	1	10B,5B series
024	A10300201A	MAGAZINE SET	1	5A series
024	A12400901A	MAGAZINE SET	1	777&779 series
025	A05502201	ROD	1	
025	A12401101	ROD	1	777&779 series
026	A05502001	ROD	1	
027	A05504001	SPRING	1	
028	A05502101	BLOCK	1	
028	A12400301	BLOCK	1	777&779 series
029	A05503001A	ANVIL A	1	
029	A12400701A	ANVIL A	1	777&779 series
029	A05503201A	ANVIL B	1	

ITEM	PARTS NO.	DESCRIPTION	Q'TY	SPEC.
029	A05503101	ANVIL CL	1	
029	A05504701	ANVIL CR	1	
029	A05504801	ANVIL DR	1	
029	A05505001	ANVIL DL	1	
030	A05504101	ROD	1	
031	A05504201	SEAL	1	
032	A05504401	PROTECT WASHER	1	
033	A05504601	SPACER	1	FOR ANVIL A,B
034	A05503601	ANVIL C-1	1	FOR ANVIL CL,CR,DR,DL
501	BAC0605202	HEX.SOC.HD.BLOT	4	M5x0.8-20
502	BAF22802	C-RING	1	φ28
503	BAB035337	O-RING	1	P34
504	BAB035214	O-RING	1	φ3.5x21.4
505	BAB024208	O-RING	1	P21
506	BAC0306252	HEX.SOC.HDLESS.	2	M6x1-25(FOR ANVIL A,B,DR,DL)
506	BAC0306162	HEX.SOC.HDLESS.	2	M6x1-16(FOR ANVIL CL,CR)
507	BAG020502	HELI-COIL	8	M5x0.8-2D
508	BAC0605142	HEX.SOC.HD.BLOT	4	M5x0.8-14
509	BAF10402	E-RING	2	φ4
510	BAA025018	SPRING PIN	1	φ2.5x18
511	BAB024118	O-RING	2	φ2.4x11.8
512	BAA030010	SPRING PIN	2	φ3x10
513	BAE01062	SPRING WASHER	1	M6
514	BAC0406352	HEX.SOC.HD.BLOT	1	M6x1-35(FOR ANVIL A,B)
514	BAC0406202	HEX.SOC.HD.BLOT	1	M6x1-20(FOR ANVIL CL,CR)
514	BAC0206402	HEX.SOC.FLAT COUNTER SUNK HD.SCREW	1	M6x1-40 (FOR ANVIL DR,DL)
515	BAC0203062	HEX.SOC.FLAT COUNTER SUNK HD.SCREW	2	M3x0.5-6 (FOR ANVIL CL,CR)
515	BAC0203102	HEX.SOC.FLAT COUNTER SUNK HD.SCREW	2	M3x0.5-10 (FOR ANVIL DL,DR)
516	BAA025012	SPRING PIN	1	φ2.5x12
517	BAA025018	SPRING PIN	1	φ2.5x18
518	A00100801	AIR PLUG	1	JAPANESE STYLE
518	A00100802	AIR PLUG	1	U.S.A. STYLE
518	A00100803	AIR PLUG	1	EUROPEAN STYLE
519	BAB026282	O-RING	1	φ2.62xφ28.25
520	BAC0605073	HEX.SOC.HD.BLOT	2	M5x0.8-7
521	A05505701	HEX.SOC.FLAT COUNTER SUNK HD.SCREW	1	M8x1.25-35 (FOR ANVIL A,B)
521	A05505601	HEX.SOC.FLAT COUNTER SUNK HD.SCREW	1	M8x1.25-20 (FOR ANVIL CL,CR)
521	A05505801	HEX.SOC.FLAT COUNTER SUNK HD.SCREW	1	M8x1.25-40 (FOR ANVIL DL,DR)
522	BAG010602	HELI-COIL	3	M6x1-2D
523	BAI0404		1	1/4"PT
524	BAA030024	SPRING PIN	2	φ3x24(FOR ANVIL A,B)
524	BAA030014	SPRING PIN	2	φ3x14(FOR ANVIL CL,CR)
524	BAA030022	SPRING PIN	2	φ3x22(FOR ANVIL DL,DR)