

MODEL : LU-1416AC

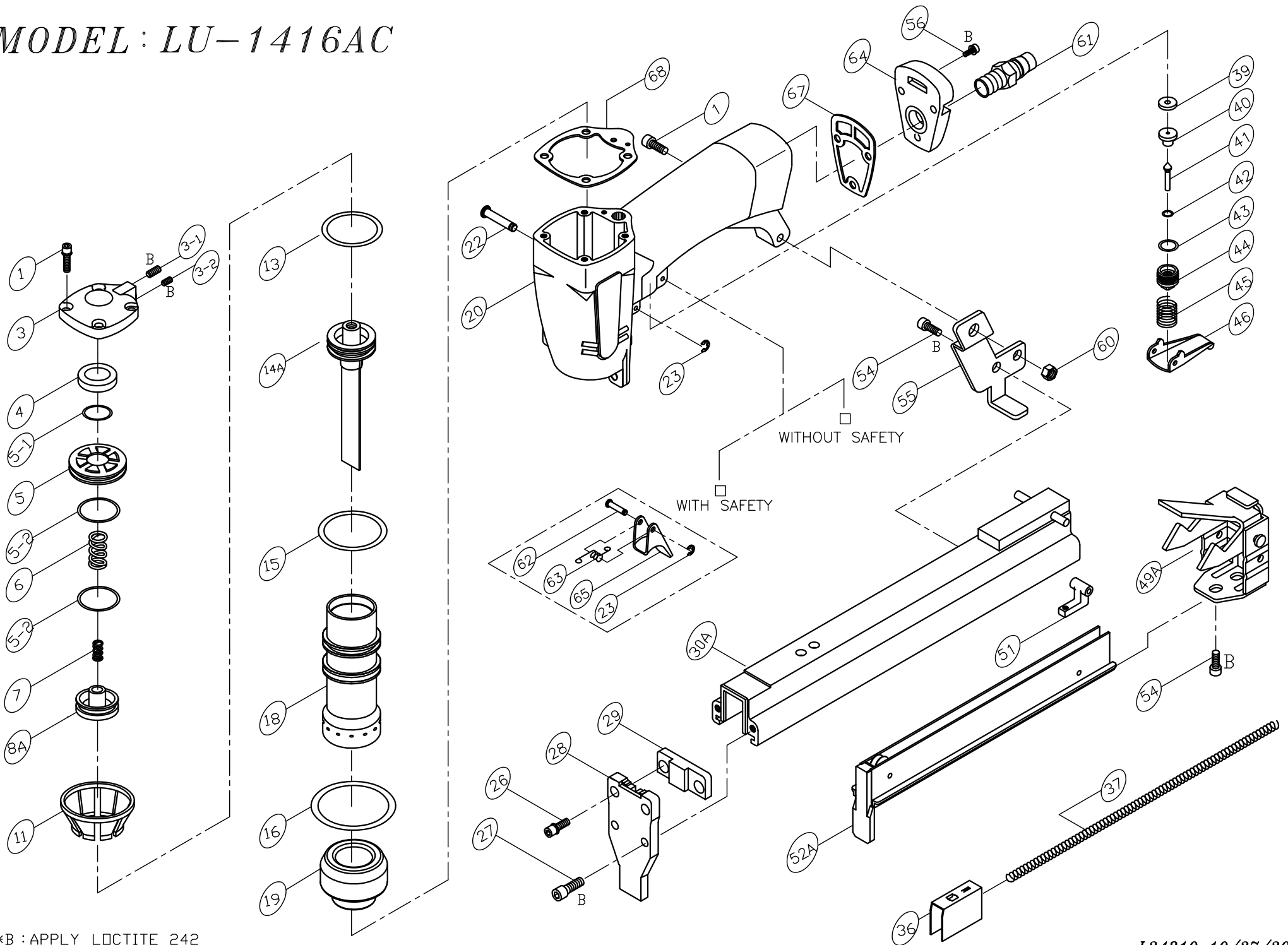

*B : APPLY LOCTITE 242

PARTS LIST (LU-1416AC)

*WHEN ORDERING SPARE PARTS, PLEASE STATE ITEM No, PART NO. AND DESCRIPTION.

ITEM	PART NO	DESCRIPTION	QTY	ITEM	PART NO	DESCRIPTION	QTY	ITEM	PART NO	DESCRIPTION	QTY
01	HS05080BW-16	HEX. SOC. HD. BOLT+SW	5	45	12103901	SPRING	1				
03	16800301	CAP	1	46	10203001	TRIGGER	1				
03-1	SS06100B-04	SET SCREW	1	49A	10405201A	END CORE ASM.	1				
03-2	SS04070B-04	SET SCREW	1	51	19004801	SET PLATE	1				
04	10200501	SEAL	1	52A	24804201A	STAPLE GUIDE UNIT	1				
05	16801301	PISTON STOPPER	1	54	HS04070B-08	HEX. SOC. HD. BOLT	4				
05-1	OR11824N	O RING**	1	55	10405601	BRACKET	1				
05-2	OR27025N	O RING**	2	56	HS04070BW-16	HEX. SOC. HD. BOLT+SW	3				
06	16800501	SPRING**	1	60	LN0500N	LOCK NUT	1				
07	10200401	SPRING**	1	61	12106401	AIR PLUG	1				
08A	10200801A	HEAD VALVE ASM.	1	62	10206201	STEPPED PIN	1				
11	10201201	COLLAR	1	63	11009101	TOR. SPRING	1				
13	OR17730N	O RING**	1	64	16806401	END CAP	1				
14A	24801402A	DRIVER ASSEMBLY**	1	65	11002801	TRIGGER	1				
15	OR31824N	O RING**	1	67	16806701	GASKET	1				
16	OR25020N	O RING	1	68	16806801	GASKET**	1				
18	16801801	CYLINDER	1								
19	24801901	BUMPER	1								
20	19602002	BODY	1								
22	10202201	STEPPED PIN	1								
23	ER0250R	E RING	2								
26	HS05080BW-18	HEX. SOC. HD. BOLT+SW	2								
27	HS04070B-12	HEX. SOC. HD. BOLT	2								
28	24803601	NOSE	1								
29	10703801	SET PLATE	1								
30A	24803801A	MAGAZINE	1								
36	24804501	PUSHER	1								
37	10404301	SPRING	1								
39	12103301	SEAL	1								
40	12103401	TRIGGER VALVE HEAD	1								
41	12103501	TRIGGER VALVE STEM	1								
42	OR01919N	O RING**	1								
43	OR10819N	O RING**	1								
44	12103801	TRIGGER VALVE GUIDE	1								